











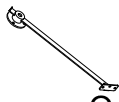

A	L
6	4



A
6

	8.0x30		3.0x13			4.0x30
B	D	G	H	S2	Q	H1
8	8	2	6	4	2	4

	8.0x30		4.0x30	
B	D	G	H1	S2
4	4	1	2	4

V-VII-IX-X-XIII

6.3X13				3.0x13			4.0x25
F	Z	X	I	H	S3	M	G
8	4	12	8	8	2	6	12

∅-10.0

KR
1

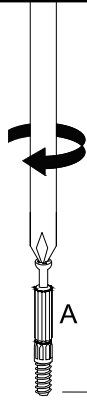
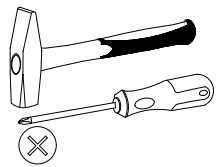
I

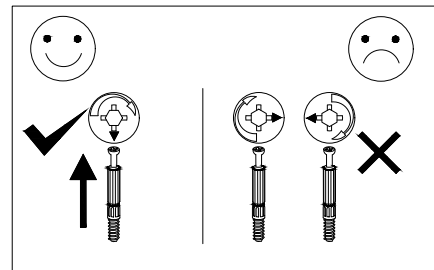
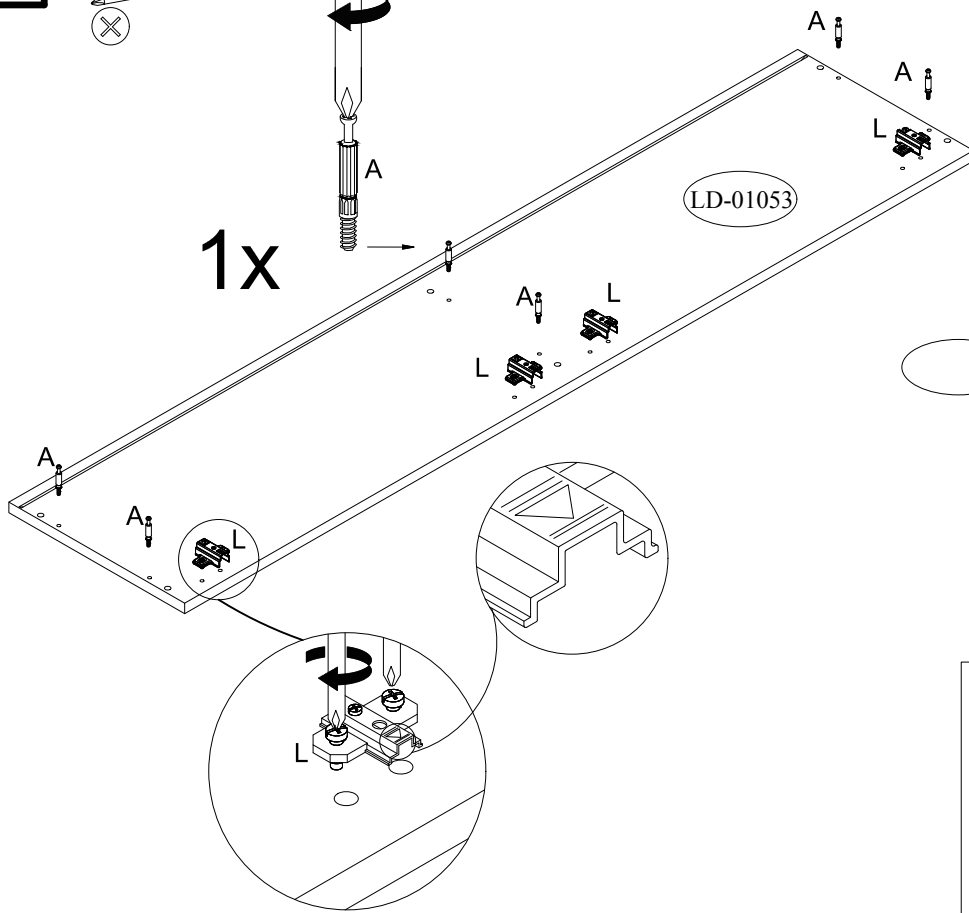

L	A
4	6



II

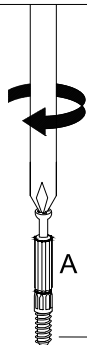
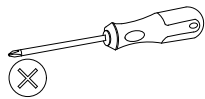

A
6

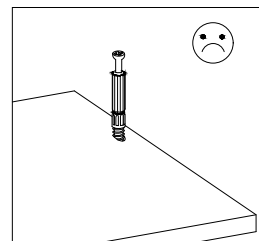
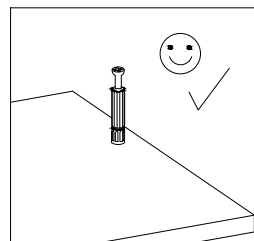
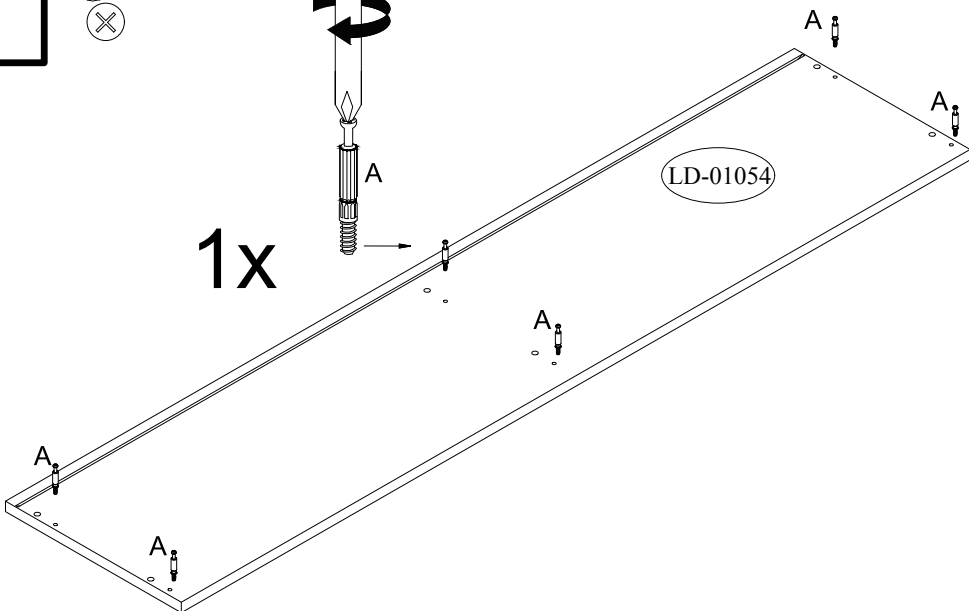

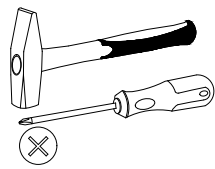

	3.0x13 		4.0x30 	8.0x30 	
S2	H	G	H1	D	B
4	6	2	4	8	8

1x

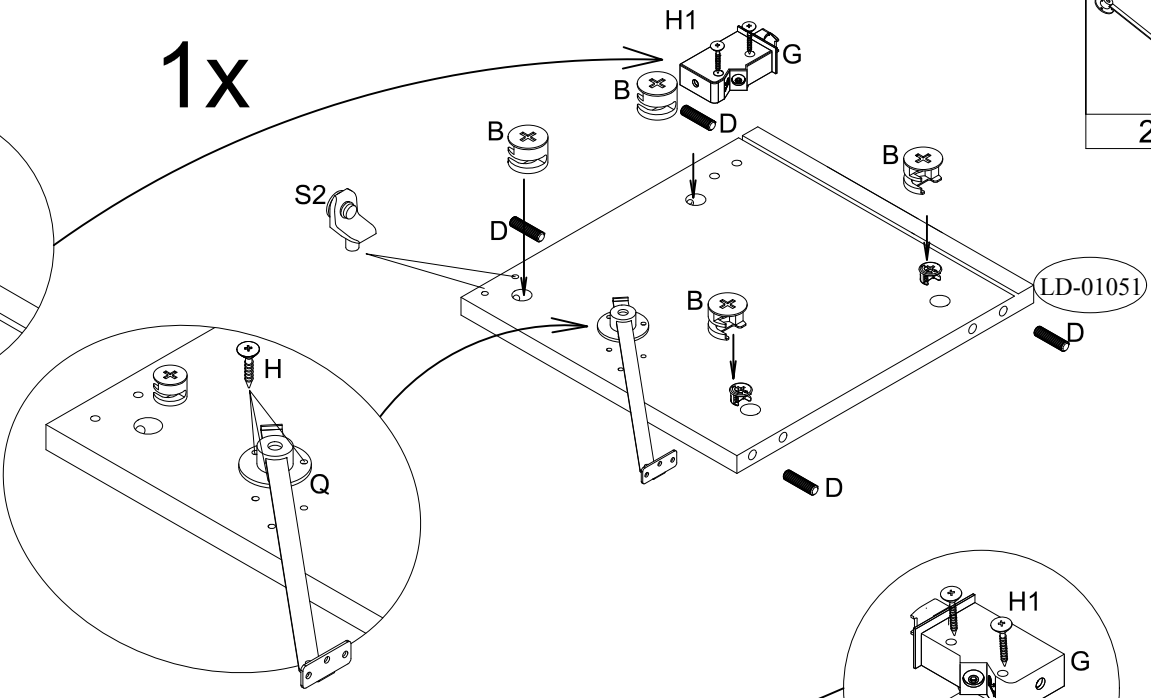
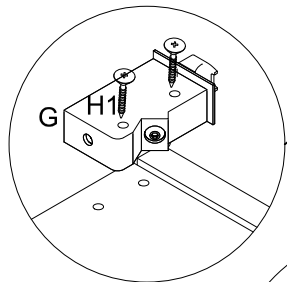

Q
2

1x

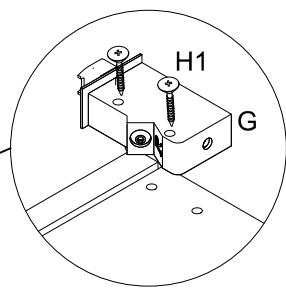
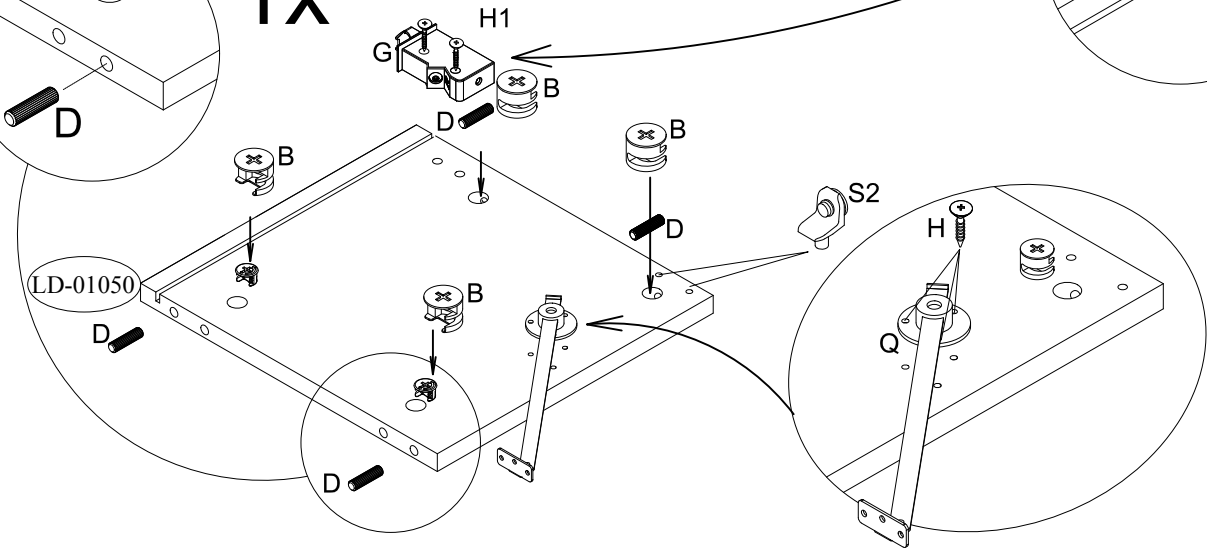
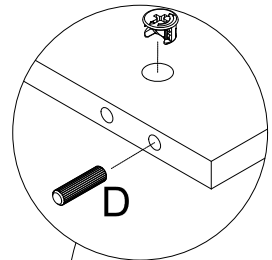

IV

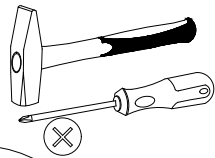

		4.0x30 	8.0x30 	
S2	G	H1	D	B
4	1	2	4	4

1x

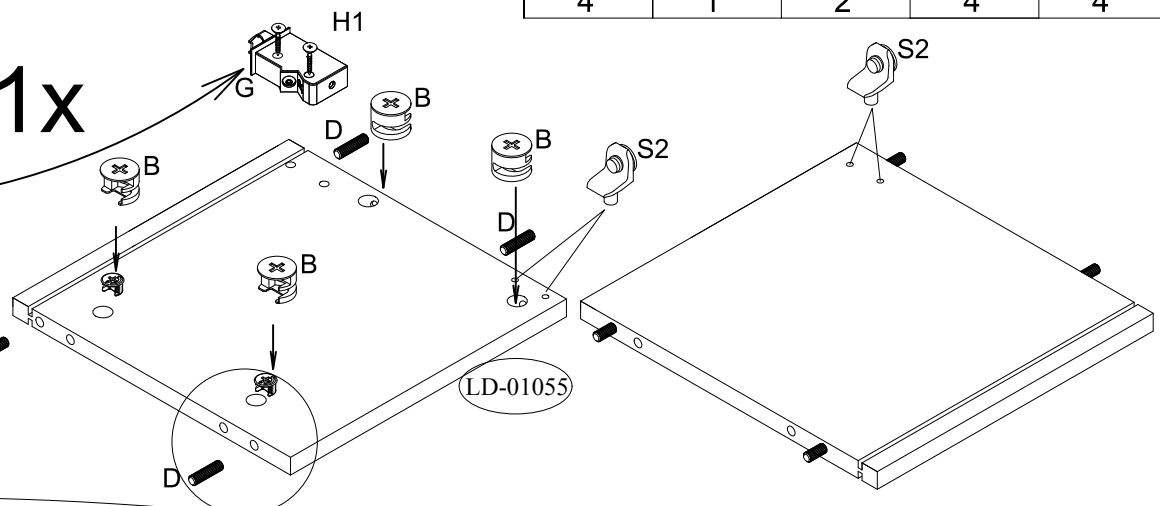
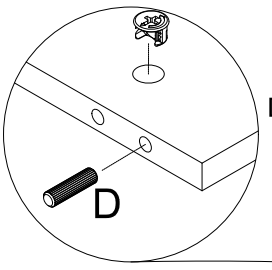
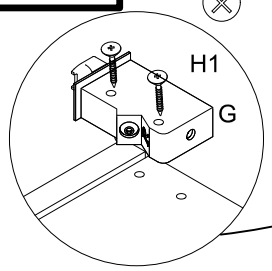

V

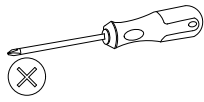

6.3X13		
	F	Z
8		4

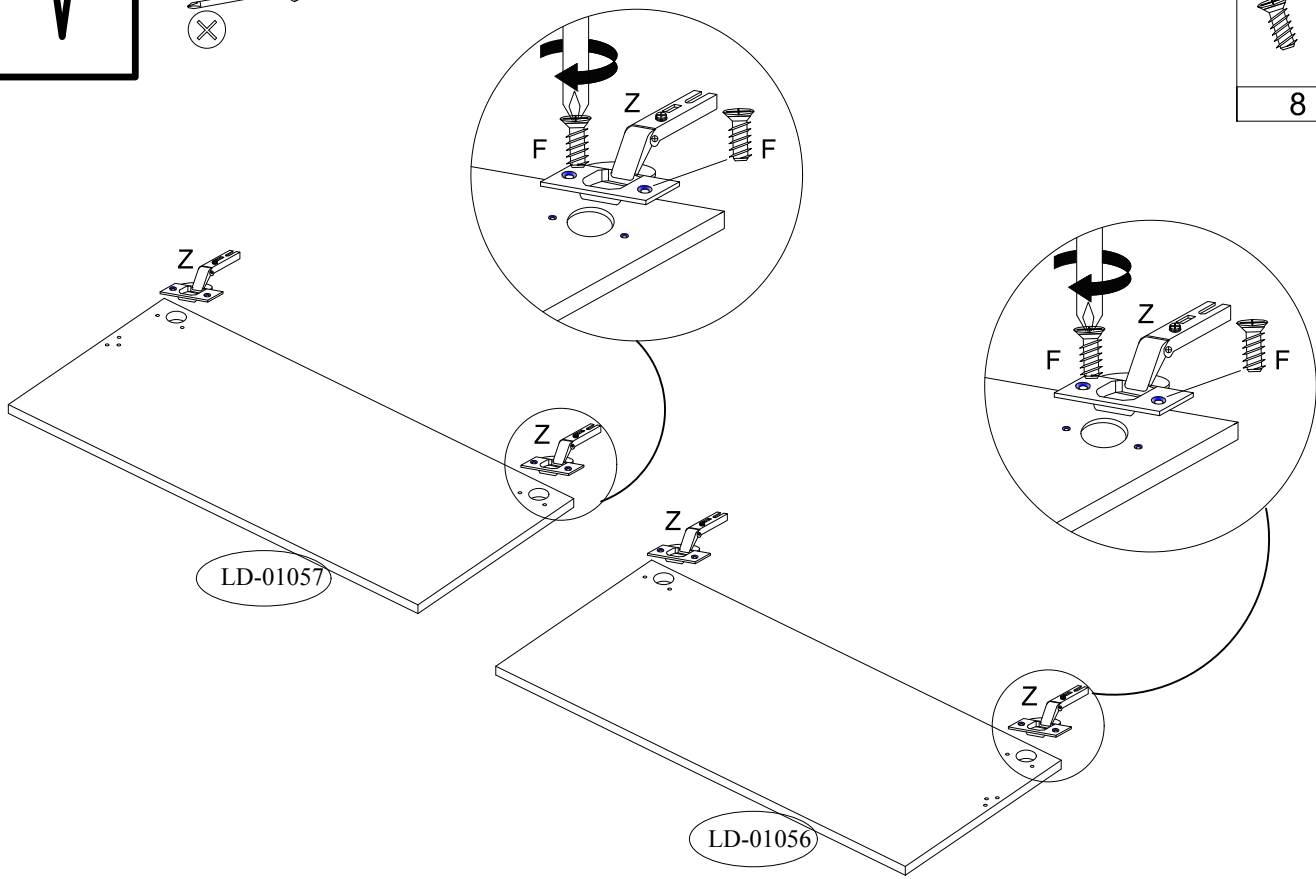

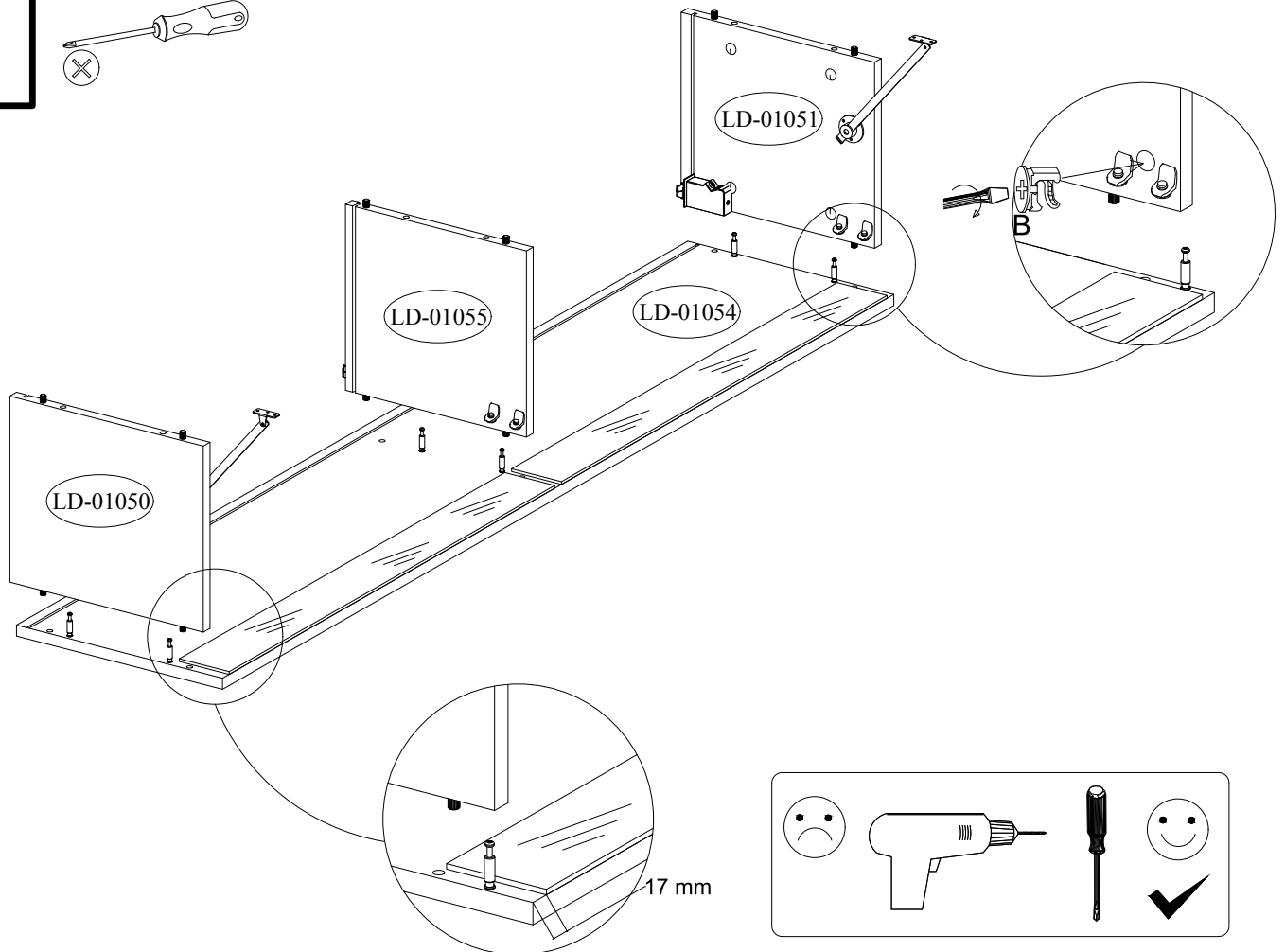
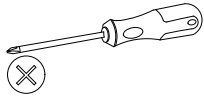

VI

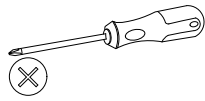

VII



3.0x13		
	H	S3
2		2

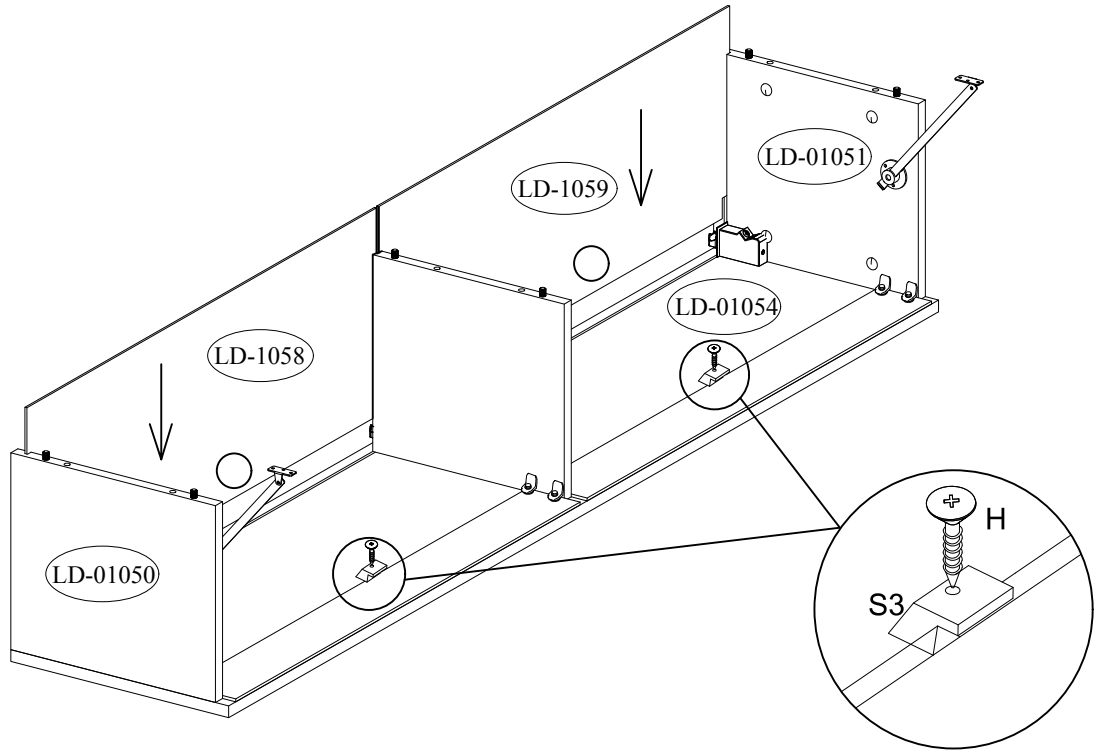

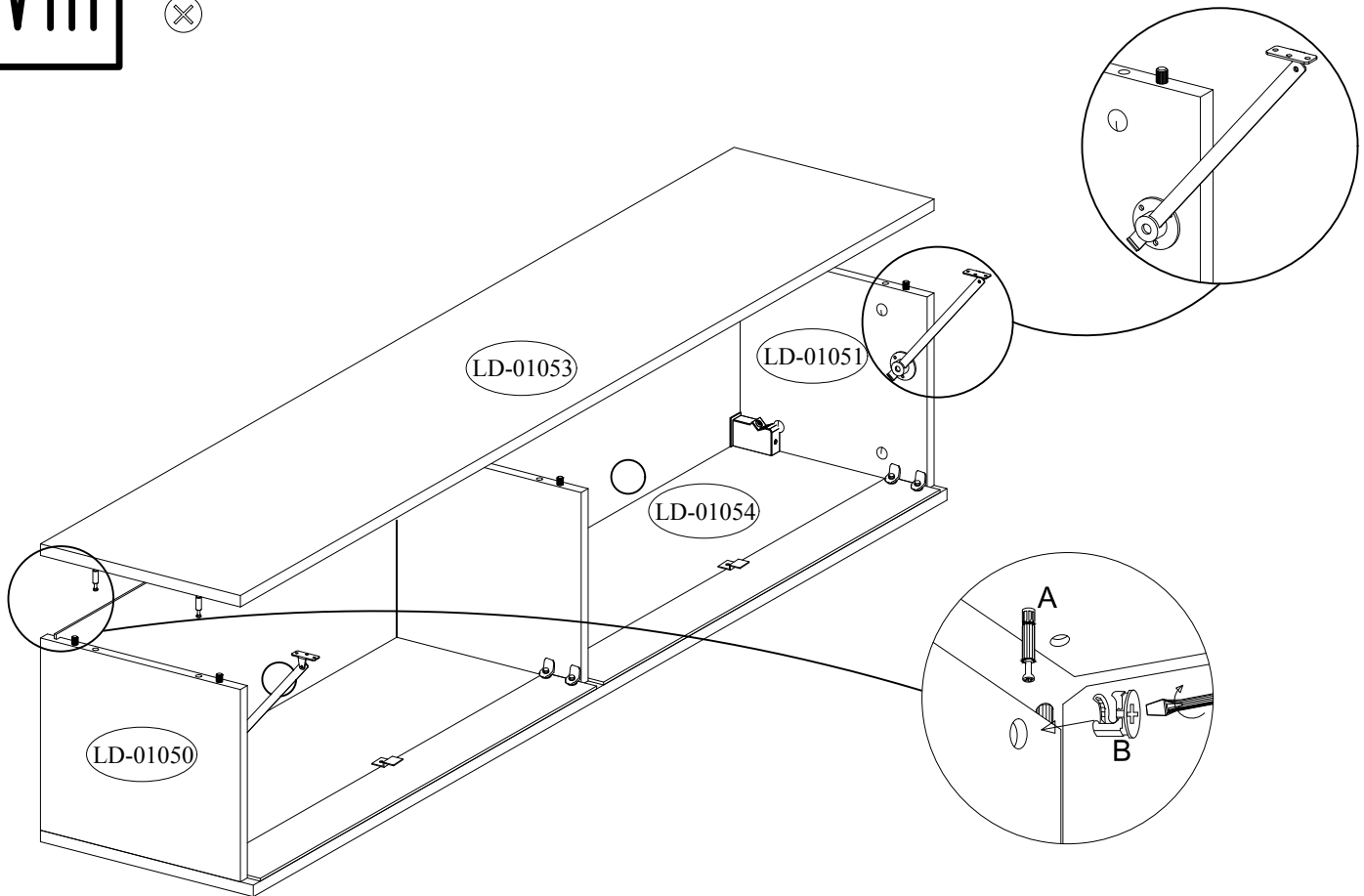
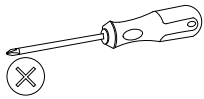

VIII

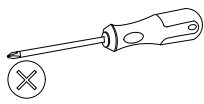

IX



3.0x13  H	 X
6	12

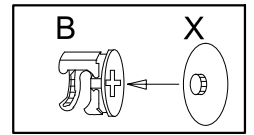
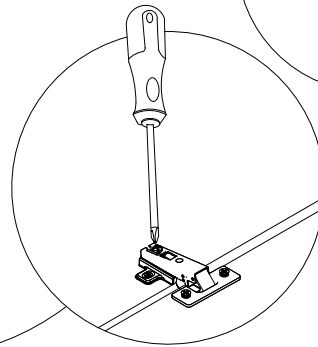
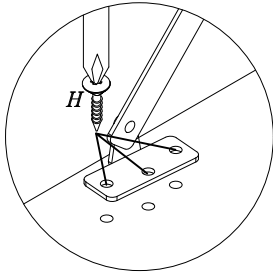
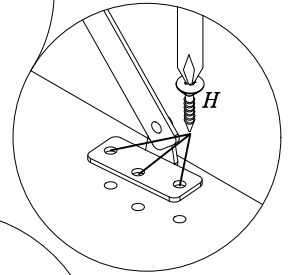
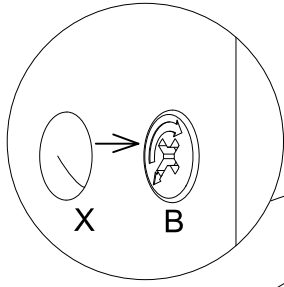
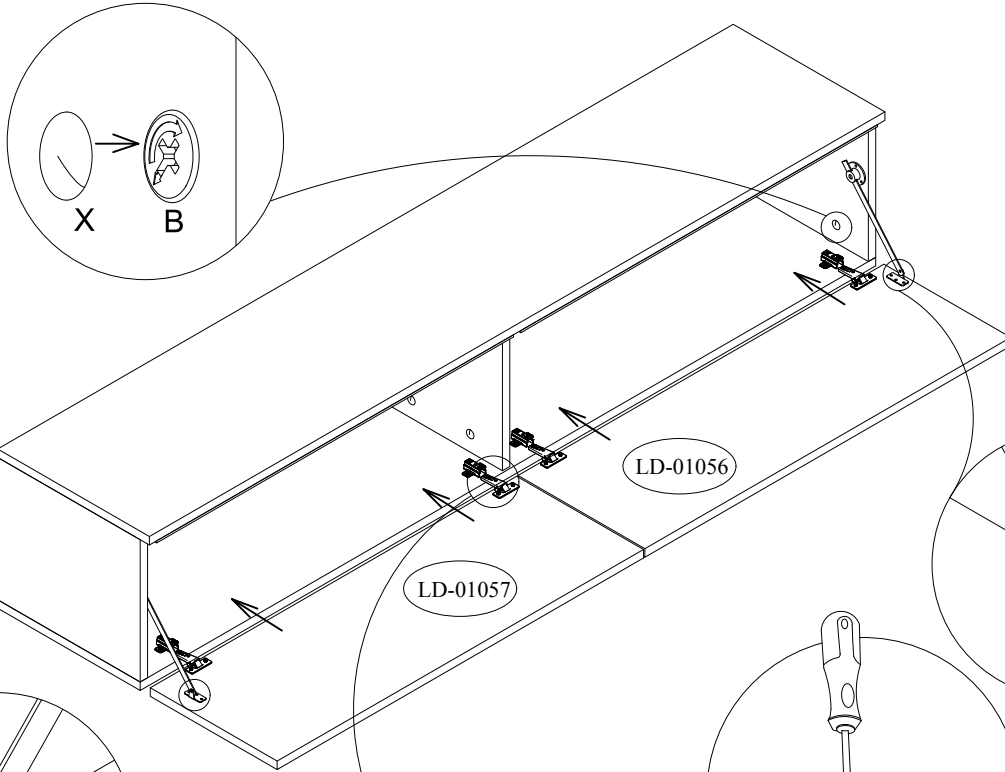

X

 I
8

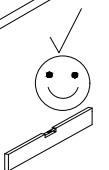
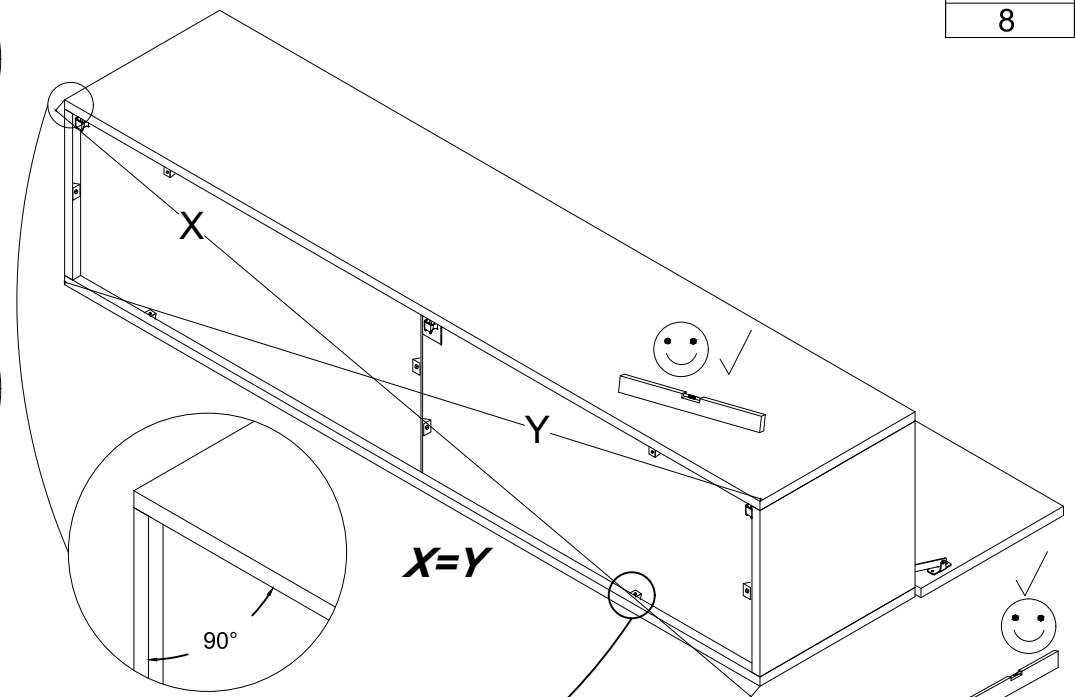
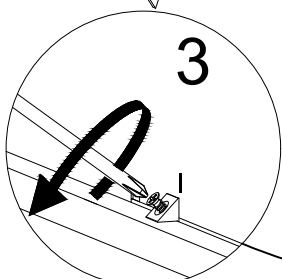
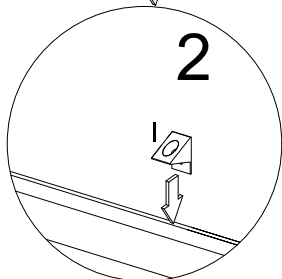
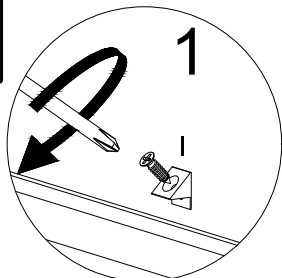

XI

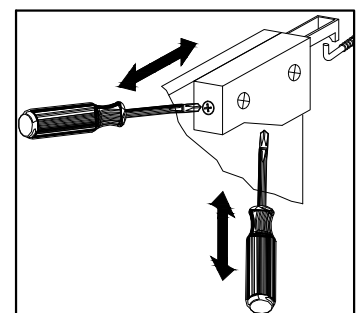
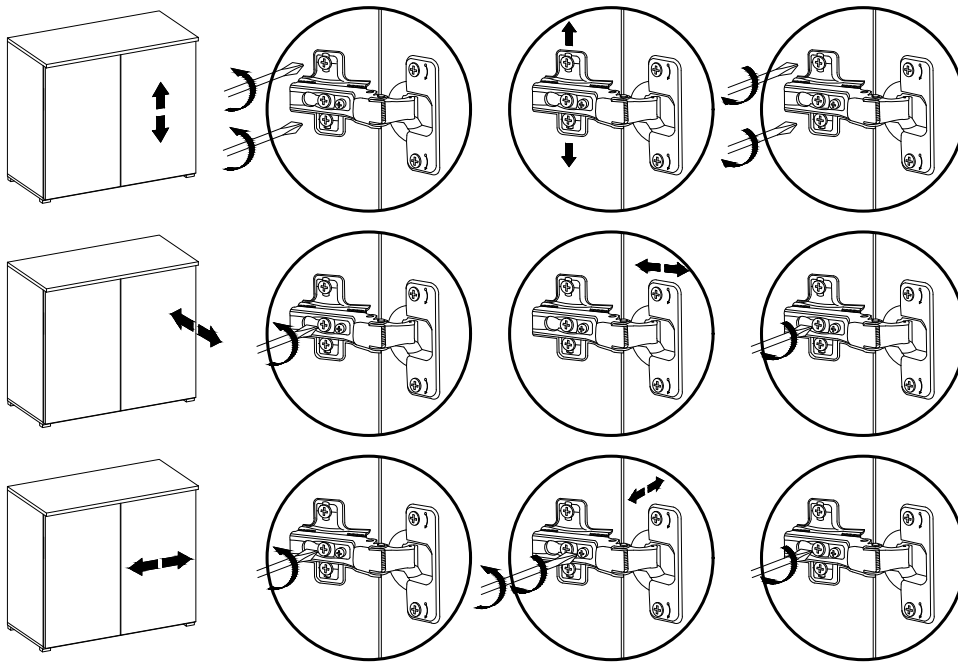
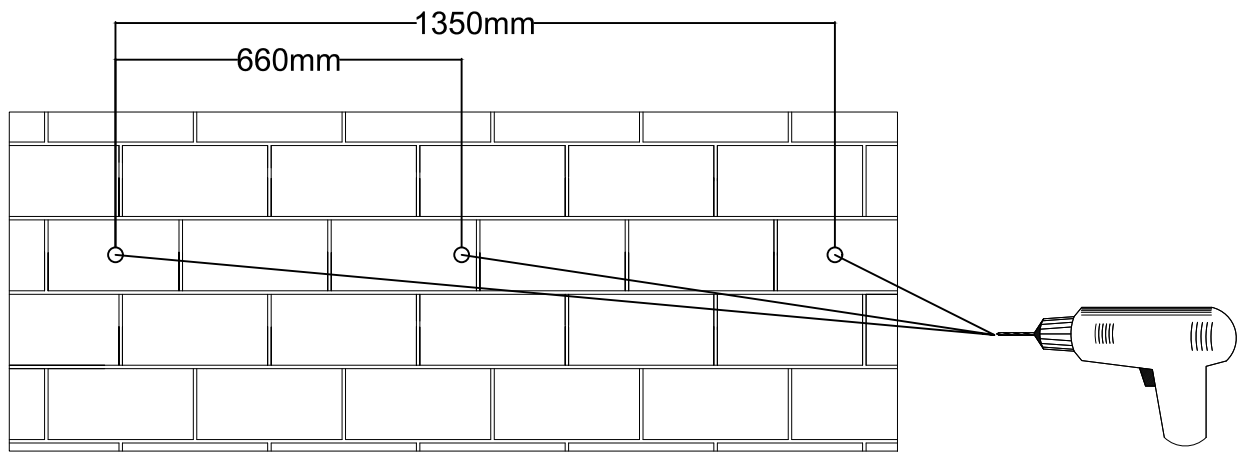

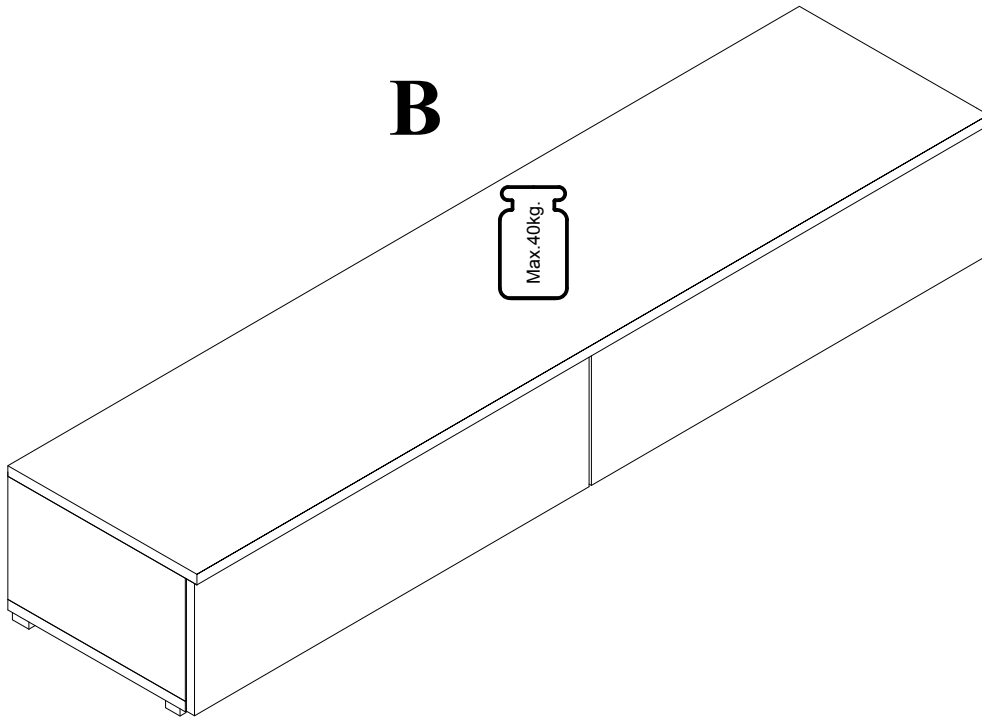

XII

B

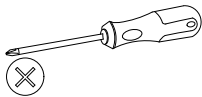

XIII



	4.0x25
M	
6	G
	12

